

High speed poppet type solenoid valves with individual electrical connections. Light weight plastic bodies with DIN rail manifold. Ideal for cabinet installations.

- High speed poppet valve
- Push-in connection
- Built-in terminal block
- Pneumatic output indicator
- DIN rail mounting





Poppet valve, not suitable for use with Soft or Slow start Valves. When pressure is applied, the double solenoid interface takes a pre-determined position (non activated). In the absence of electrical signal, output 2 (yellow indicator) is activated, output 4 (red indicator) is non activated. Double solenoid version is delivered as standard with Non locking flush override.

Operating information

Working pressure;	
3/2 and 4/2:	3-8 bar
Low pressure interface 3/2:	1-8 bar
Flow (Qmax):	200 l/min
Working temperature	-15 °C to +60 °C
For more information see www.parker.com/euro_pneumatic	

Head and tail sets - intermediate supply modules

For 3/2 and 4/2 interface modules

	Description	Characteristics	Pneumatic connection	Weight (g)	Order code
	Set for single air supply connection	1 electrical common terminal 1 main air supply port 1 exhaust port	Push-in Ø 6 mm G1/8	100 100	PS1-E101 PS1-E1018
	Set for double air supply connection	1 electrical common terminal 2 main air supply ports 2 exhaust ports	Push-in Ø 6 mm G1/8	125 125	PS1-E102 PS1-E1028
	Intermediate air supply module	1 air supply port 1 exhaust port <i>(see description below)</i>	G1/8	45	PS1-E1038

Incorporating an intermediate air supply module into a group of electro-pneumatic modules gives the following options :

Air supply connection

- Additional G1/8 port to supplement the air supply to the manifold
- Blank the common air supply, enabling different pressures to be supplied to groups of modules within the manifold.

Exhaust connection









- Additional exhaust flow through the G1/8 port
- Blank the common exhaust, enabling separation of exhaust from module groups

The intermediate air supply module is supplied with 4 interchangeable connectors to enable the above supply options to be achieved.

Electro-pneumatic modules

Modules without solenoid valve

Visual indication of pneumatic output status : Closed = Red Open = Yellow

	Symbol function	Description	Pneumatic connection	Weight (g)	Order code
		3/2 normally closed (NC)	Push-in Ø 4 mm	52	PS1-E111
			M5	55	PS1-E115
			Push-in Ø 6 mm	55	PS1-E116
		3/2 normally open (NO)	Push-in Ø 4 mm	52	PS1-E121
			M5	55	PS1-E125
			Push-in Ø 6 mm	55	PS1-E126
		4/2 single solenoid / spring return	Push-in Ø 4 mm	120	PS1-E181
			M5	120	PS1-E185
			Push-in Ø 6 mm	125	PS1-E186
		4/2 double solenoid	Push-in Ø 4 mm	120	PS1-E191
			M5	120	PS1-E195
			Push-in Ø 6 mm	125	PS1-E196

Low pressure Electro-Pneumatic modules 3/2 (1 to 8 bar)

Modules without solenoid valve

Visual indication of pneumatic output status : Closed = Red Open = Yellow

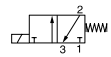
	Symbol	Description	Pneumatic connection	Weight (g)	Order code
		3/2 normally closed (NC)	Push-in Ø 4 mm	52	PS1-E311
			M5	52	PS1-E315
			Push-in Ø 6 mm	52	PS1-E316

15mm DIN Form C (8mm spacing) pilot solenoid valve



For use with Valve module

	Manual Overrides		Flush (Not Extended)			Extended	
	Voltage	W (g)	Without Manual Override Order code	Blue Override, non locking Order code	Yellow Override, Locking Order code	Blue Override, non locking Order code	Yellow Override, Locking Order code
	12 Vdc	38	P2E-KS32B0	P2E-KS32B1	P2E-KS32B2	P2E-KS32B3	P2E-KS32B4
	24 Vdc	38	P2E-KS32C0	P2E-KS32C1	P2E-KS32C2	P2E-KS32C3	P2E-KS32C4
	48 Vdc	38	P2E-KS32D0	P2E-KS32D1	P2E-KS32D2	P2E-KS32D3	P2E-KS32D4
	24 Vac 50Hz	38	P2E-KS31C0	P2E-KS31C1	P2E-KS31C2	P2E-KS31C3	P2E-KS31C4
	48 Vac 50/60Hz	38	P2E-KS34D0	P2E-KS34D1	P2E-KS34D2	P2E-KS34D3	P2E-KS34D4
	115 Vac 50Hz	38	P2E-KS31F0	P2E-KS31F1	P2E-KS31F2	P2E-KS31F3	P2E-KS31F4
	120 Vac 60 Hz						
	230 Vac 50Hz	38	P2E-KS31J0	P2E-KS31J1	P2E-KS31J2	P2E-KS31J3	P2E-KS31J4
	240 Vac 60 Hz						

Mounting screws included with the valve module

Suppressor and LED indicators







For 8 mm solenoid pin spacing - For mounting between the valve body and the 15 mm pilot solenoid valve

	Symbol	Description	Pneumatic connection	Weight (g)	Order code
		LED indicator	24 VAC/DC	3	P8V-CR26C
			115 VAC 50 Hz - 120 VAC 60 Hz	3	P8V-CR24F
			230 VAC 50 Hz - 240 VAC 60 Hz	3	P8V-CR24J

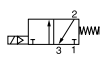
Electro-pneumatic modules

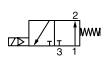
Modules including 24 VDC solenoid valve - Flush non locking manual override (using P2E-KS32C1 solenoid)

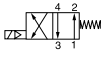
Visual indication of pneumatic output status : Closed = Red Open = Yellow

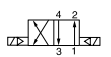
	Symbol	Description	Manual override	Pneumatic connection	Weight (g)	Order code
		3/2 normally closed (NC) Spring return		Push-in Ø 4 mm 90		PS1-E21102B
		3/2 normally open (NO) Spring return		Push-in Ø 4 mm	90	PS1-E22102B
		4/2 single solenoid / spring return		Push-in Ø 4 mm	160	PS1-E28102B
		4/2 double solenoid	-	Push-in Ø 4 mm	200	PS1-E29102B

Maintenance avertissement - Solenoid pin spacing



The electro-pneumatic interface modules have been re-designed to accept both 8 mm and 9,4 mm solenoid pin spacing. If you are purchasing a solenoid or a suppressor & LED indicator for maintenance on an electro-pneumatic interface module purchased before June 2004, above solenoid P2E-KS3xxx and P8V-CRxxx (8 mm pin spacing) will not be compatible. Please, contact your Parker customer service.

Accessories : Pressure switch

With Ø4 push in connection (pneumatic input)
With electrical terminals 1,5 mm² (electric output)

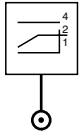
Type	Symbol	Electrical characteristics	Pneumatic characteristics	Override	Weight (g)	Order code
		Pressure switch 1 CO contact 5 A/250 V	Fixed operating threshold < 1,3 bar	Manual override	50	PS1-P1081
			Adjustable operating threshold 2 to 5 bar	Manual override	50	PS1-P1091

Technical characteristics : Pressure switch

- Effective detection for preventing hazardous risks linked with equipments operating at to low pressure
- Manual override
- Easy clip on DIN rail mounting
- Fixed or adjustable threshold versions
- Recessed Electrical Terminals

Working pressure	Max 10 bar
Working temperature	-15 °C to +60 °C
Minimum actuating pressure, non adjustable	≤1,3 bar
Minimum actuating pressure, adjustable 2 to 5 bar	
Operating frequency	Max 10 Hz
Nominal isolation voltage	660 V AC or DC
Nominal thermal current	10 A
Operating voltage	250 V
Pending current	5 A
Protection level	IP 40
According Power switches (inductive load)	

Electrical durability

	24 VAC	48 VAC	115 VAC	24 VDC	48 VDC	115 VDC
1 million	25 VA	56 VA	115 VA	24 W	37 W	50 W
2 million	-	-	-	14 W	25 W	40 W
5 million	10 VA	14 VA	19 VA	-	-	-

Dimensions, PS1 valve Series

Electropneumatic interface modules 3/2 NC or NO

3/2 modules equipped with solenoid
Head and tail set for single air supply connection

3/2 modules equipped with solenoid, suppressor and LED indicator
Head and tail set for double air supply connection

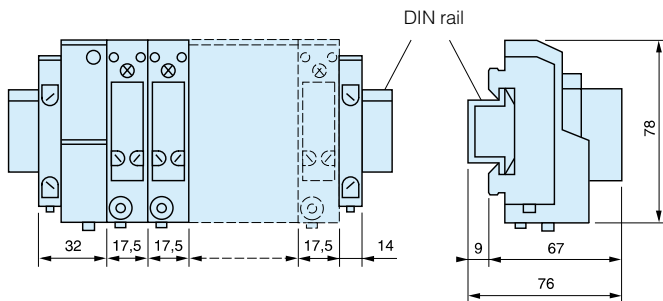

Total length (mm)
L = 46 + (n x 17,5)
n = number of modules

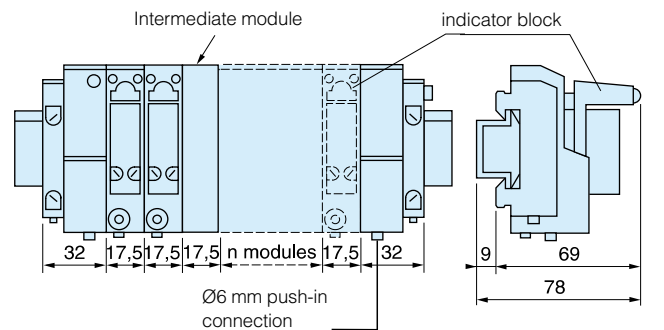

Total length (mm)
L = 64 + (n x 17,5)
n = number of modules

Electropneumatic interface modules 4/2 single or double solenoid

4/2 modules equipped with solenoid, suppressor and LED indicator
Head and tail set for double air supply connection

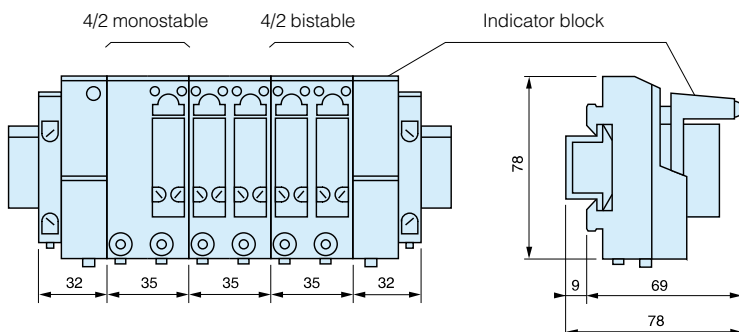

Total length (mm)
L = 64 + (n x 35)
n = number of modules